

# M.2005D

- Clé Mémotork
- Memotork wrench
- Memotork  
Drehmomentschlüssel
- Memotork sleutel
- Llave Memotork
- Chiave Memotork

Notice d'instructions  
Instruction manual  
Bedienungsanleitung  
Gebruiksaanwijzing  
Guia de instrucciones  
Istruzioni per l'utilizzo  
**NU-M.2005D/95**

<b>Sommaire</b>	<b>page</b>
Caractéristiques techniques	4
Description	5
Préparation de la clé	6
Principe de fonctionnement	7
Changement d'unité et horloge	8
Utilisation en lecture directe	9
Choix d'un seuil de couple	10
Mémorisation des serrages	11
Effacement de la mémoire	12
Sortie imprimante ou ordinateur	12
Table des codes erreurs	13
Maintenance de la précision	14
Lexique des termes et messages utilisés	15

<b>Contents</b>	<b>page</b>
Technical specifications	16
Description	17
Preparing the wrench	18
Operating principle	19
Changing units and clock settings	20
Direct reading	21
Choosing a torque limit	22
Storing tensioning settings in memory	23
Clearing the memory	24
Printer or computer output	24
Error code table	25
Maintenance of precision	26
Glossary of terms and messages used	27

<b>Inhaltsverzeichnis</b>	<b>Seite</b>
Technische Daten	28
Beschreibung	29
Vorbereitung des Drehmomentschlüssels	30
Funktionsprinzip	31
Umstellen der Meßeinheit - Zeituhr	32
Direktes Ablesen	33
Einstellen eines Drehmomentschwellenwerts	34
Speichern der Anziehvorgänge	35
Löschen des Speichers	36
Ausgabe an Drucker oder Computer	36
Liste der Fehlermeldungen	37
Einhalten der Präzision	38
Liste der verwendeten Ausdrücke und Meldungen	39



## Description

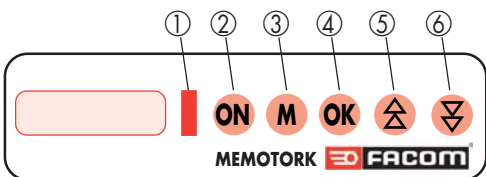

## Keypad

As a safety precaution, an acoustic signal is given each time a key is pressed.

- ① **LED** : Red light, complements acoustic alarm.
- ② **ON** : Wrench is on. (*automatic switch-off, see page 18*)
- ③ **M** : Select operating mode.
- ④ **OK** : Confirmation of selection. Also used to reset to zero.
- ⑤ ⑥ Allow fast or slow setting of torque limit, and also recall of stored settings.

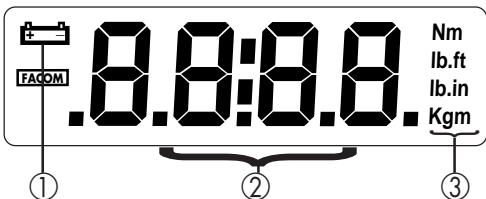

## Display *(4 digits + symbols)*

- ① Battery alarm (*see page 26*)
- ② Alphanumeric display. Shows operating modes; torque values, tensioning setting numbers, date, hour, minute and error messages.
- ③ Units of measure.

# Preparing the wrench



4 charged batteries

**To insert batteries** : remove screw from the back of the wrench. Take out the power pack and insert the 4 batteries.

**1** - Press **ON**. The wrench gives three beep tones and displays **E5E**, then performs a function check and reaches its calibrated setting.

**2** - If this is the first startup after battery charging, the wrench will be in direct reading mode, in Nm.

**3** - If the wrench has already been used, it will be set to the mode and unit being used when it was last switched off.

**4** - Confirm your selection using the **OK** key. Or select a different mode (see page 7) and confirm using the **OK** key.

## Automatic switch-off

- If the wrench is not used for 50 seconds, it partially switches off to save battery power. The display switches off and the buzzer gives a beep tone every 5 seconds to indicate standby status.
- If the wrench is not used for 4 minutes, it switches off completely.
- To switch off the wrench before the 4 minute delay expires, press any key except the **ON** key: the wrench gives three beep tones and switches off. Otherwise, press the **ON** key to reset the wrench to operating mode.

## Tip

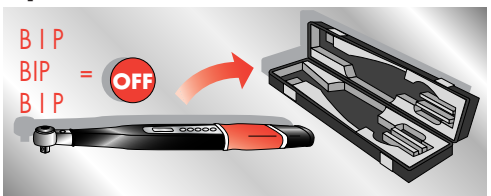

# Operating principle

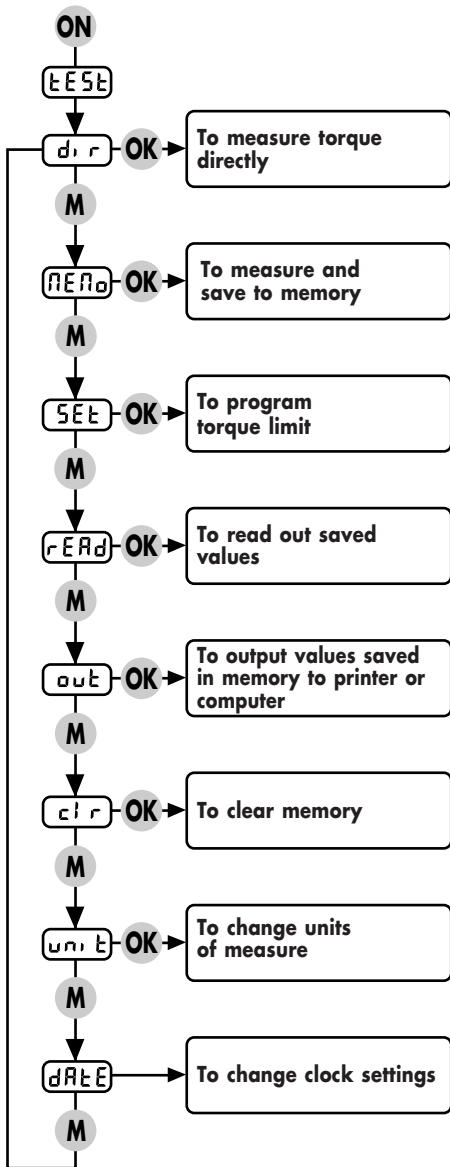

## Tip

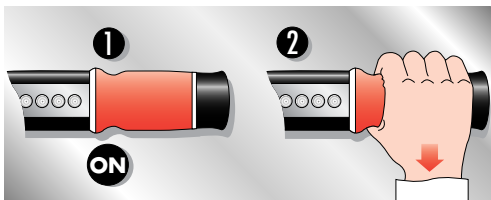

## Changing units

u n i t

There are four units available (*Nm, mkg, Lb/ft and Lb/in*). To select a unit, press the **M** key until the message **u n i t** appears. Press **OK** to confirm. Press the **▲** or **▼** key to make the desired unit flash on and off. Press the **OK** key to confirm selection and exit **u n i t**.

## Changing clock settings

d A t E

Find the message **d A t E** using the **M** key. This message is displayed for a few seconds; then month and date followed by hour and minutes are shown in sequence. Press **OK**. The month flashes on and off on the display. Press the **▲** key to set the current month, then press **OK** to confirm. The date now automatically flashes on and off. Set the current date using the **▼** key and confirm using the **OK** key. The hour and minutes appear next: proceed in the same way. Once the minutes are confirmed the **d A t E** message reappears and the values selected are displayed in turn. If they are as you want, press the **M** key to leave **d A t E** mode. If not, press **OK** and restart the clock setting procedure.

**NOTE:** When first used, or after the batteries have been changed, the wrench selects month 01, date 01, hour 00 and minute 00.

## Tip

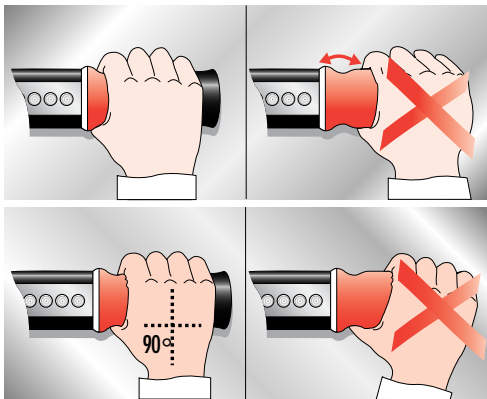

## Direct reading



Press **M** until **d, r** is displayed. Confirm selection by pressing **OK**: the message **0.00** will appear.

Tensioning can now begin.

### Tensioning

**A** - Position wrench perpendicularly to the axis of tensioning.

**B** - Position hand in the middle of grip.

**C** - Pull on the wrench with a gradual perpendicular movement.

**D** - Note the increase in torque shown on the display and stop pulling immediately the desired torque is displayed. The wrench displays the maximum torque applied.

**E** - There are three ways of moving on to the next tensioning operation:

- E1 - Reduce the torque level to below 10% of the wrench's maximum capacity; this is taken into account when a new torque setting is applied.

- E2 - Wait for 15 seconds, after which the first displayed torque setting will be cleared and the second tensioning operation can be performed.

- E3 - Press **OK**: the first torque setting will be cleared and the second tensioning operation can be performed.

If the wrench's maximum capacity is reached, the message **StoP** appears and a beep tone sounds. If 120% of the maximum capacity is reached, the message **Err5** appears and a continuous beep tone sounds (*see error table on page 25*).

### Tip

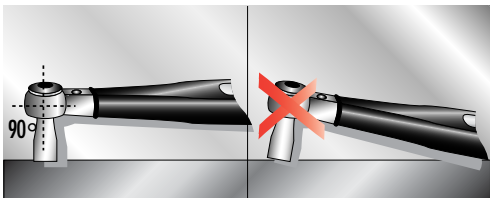



## Choosing a torque limit

SEt

The desired torque value (*limit*) for tensioning is programmable. The wrench automatically signals when this limit is reached (*beep tone and lit signal*).

**A** - Press **M** until message SEt appears.

**B** - Confirm selection using **OK**; the display shows the previously programmed limit or an automatic limit equivalent to 10% of the wrench's maximum capacity.

**C** - To modify the limit use the **▲** and **▼** keys. Using the keys to alter the limit will cause an equivalent increase or decrease in the applied power of the wrench. A fast numerical scan can be obtained by pressing the appropriate key for more than 2 seconds.

**D** - Confirm the limit using **OK**.

**E** - The wrench switches to memory mode and the display shows the limit and the tensioning number in turn.

**NOTE:** When no limit is entered (*display is clear*), it is possible to work without a warning light or a beep tone.

### Tip

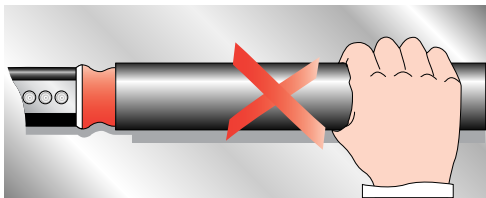
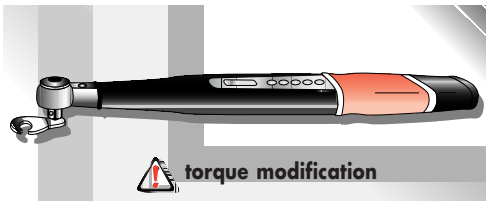

## Storing tensioning settings in memory

MEMO

The tensioning operation can be stored in memory with or without a torque limit being programmed.

- A** - Press **M** until message **MEMO** appears.
- B** - Confirm using **OK**; the display shows the limit and the tensioning number in turn.
- C** - Perform the tensioning operation. The torque progression is indicated by a beep tone which increases in intensity as the torque increases.
- D** - When the limit is reached the beep tone and flashing led display both become continuous.
- E** - Once the limit is reached, there is an interval of 15 seconds for saving it by pressing **OK**. While saving is taking place the message **! oAd** is displayed. Once the save operation is finished the wrench automatically moves on to the next tensioning value and the tensioning number increases by one.
- F** - If the limit is not saved to memory, the next tensioning value can be accessed by reducing the applied torque to below 10% of the wrench's capacity or by waiting for 15 seconds.
- When the memory is full, the wrench displays the message **Full**.
  - Exit from **MEMO** mode using **M** key.

## Reading saved values

rEAd

- A** - Press **M** until message **rEAd** appears.
- B** - Confirm selection using **OK**. The display will show in turn the number of the last tensioning operation performed and its value.
- C** - Using the **▲** and **▼** keys it is possible to scan through the values saved in the memory.
- If the memory is empty the display flashes the message **0000**. The wrench then automatically returns to direct reading mode.
  - Exit from **rEAd** mode using **M** key.

## Clearing saved values from memory

**clr**

- A** - Press **M** until message **clr** appears.
- B** - Confirm selection using **OK**. The display will show a flashing **clr** message.
- C** - If data is to be cleared, confirm once more using **OK**. When the memory is empty the display shows the message **End** and the wrench makes 3 beep tones. If the data is not to be cleared, exit **clr** mode using **M** key before second confirmation.
- D** - After 2 seconds the wrench moves to direct reading mode.

## Transferring stored data from memory to a printer or computer

**out**

- A** - Press **M** until message **out** appears.
- B** - Confirm selection using **OK**. The display will show one of the following flashing messages:
- **out1** for computer transfer or fast printer with memory.
  - **out2** for normal printers.
- Using the **▲** key select **out1** or **out2** and confirm using **OK**. The display flashes **out1** or **out2** during transfer.
- C** - When transmission is finished the display shows the message **End** and the wrench makes three beep tones.
- D** - Use the **OK** key to repeat the operation, or exit **out** mode by using the **M** key.
- Values remain stored in wrench memory in all cases (*precaution against paper jam*).
  - The printout shows: the tensioning setting number, the date and time of storage in memory, the torque value in the unit of measure selected at the time of printing.
- The tensioning operations performed can therefore be printed out in the desired units.
- Anticlockwise torque values are preceded by a "-" sign.
  - If the torque exceeds the threshold of 4%, an asterisk (\*) will appear on the printed record.
  - If the torque exceeds the threshold of 8%, two asterisks (\*\*) will show on the printed record.
  - To interrupt data transmission, press **M**.
  - If the memory is empty, the wrench display flashes **0000** then moves to direct reading.
  - Exit **out** mode using **M** key.

## Error code table

Each error message is preceded by a beep tone

Err

**Err1** : Problem with torque gauge.

- Exit **Err1** using **M** key.
- Tensioning torque can no longer be measured; other modes remain functional.
- Wrench must be returned for repair.

**Err2** : Problem with zero reset.

- Check that the wrench has not been activated with torque already applied.
- If no torque can be applied by pressing **ON** key again, wrench must be returned for repair.
- Tensioning torque can no longer be measured but other modes remain functional.

**Err3** : Problem with memory or with clock.

- Exit from **Err3** occurs when wrench switches off automatically.
- If message persists after several attempts, wrench must be returned for repair.

**Err4** : Problem with RS.232 output.

- Exit **Err4** using **M** key.
- All modes remain functional except **out** mode for data transfer. If message persists after several attempts, wrench must be returned for repair.

**Err5** : Excess load on wrench.

- Error message appears when torque of 120% of maximum capacity is applied to the wrench. A two-tone beep sounds.
- Exit from **Err5** occurs when wrench switches off automatically.

**Err6** : Problem with wrench body.

- Wrench must be returned for repair.

## Tip

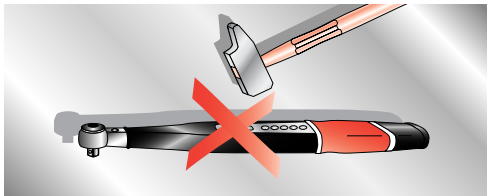

## Battery alarm



- If voltage drops below 4.3 V, the wrench makes three beep tones three times consecutively and the  symbol appears.
- There is a time interval of 20 minutes to finish tensioning operations and transfer values to memory.
- Before stopping definitively, the wrench emits a continuous beep tone and the message **bAt** appears.

## Recommendations

- Never exceed the maximum torque of your wrench, especially when untightening an object or tensioning at an angle.
- Use a dry cloth to clean your wrench: do not use either solvents or detergents.
- Do not take your wrench to pieces.

## Ensuring precision

- It is recommended that you have your wrench checked periodically (*around once a year or more often if it is used intensively*).
-  If the wrench is dropped, return it to eliminate any risk of accident.

### **Precision checking and updating of documents:**

- The FACOM measurement laboratory offers the following services:

**Inspection report:** Inspection and adjustment (*if necessary*) at 20%, 60% and 100% of wrench capacity to within the standard tolerances. Issue of a dated and numbered inspection report.

**Calibration certificate:** Inspection and adjustment of the wrench at from 6 to 12 points using inspection equipment in conformity with the national measurement standard. Issue of a dated and numbered official certificate.

For further information, consult your dealer.



**Always return your wrench with battery for repair or calibration.**

# Glossary of terms and messages used

## Terms used

**Capacity:** Defines the wrench's range of use. The requirements and testing methods of Standards **ISO 6789** and **EN26789** cover a specific range of measurement from 20% to 100% of the maximum torque value of the wrench.

**Resolution:** Smaller variation of torque visible on wrench display.

**Limit:** Value of "target" torque which tensioning must reach as closely as possible.

**Inspection report:** Document attesting to the precision of a dynamometric tool. Standard **NFX07-011** defines the information contained in this document.

**Led:** High-intensity warning light.

**Buzzer:** High-intensity acoustic (*beep*) alarm.

## Messages used

**d, r** : Direct reading of torque mode.

**SEt** : Torque limit adjustment mode.

**MEMo** : Memory mode.

**LoAd** : Indicates torque setting is being saved to memory.

**rEAd** : Read values saved to memory.

**out** : Transfer of data saved to memory to a printer or computer.

**cl r** : Memory clear mode.

**End** : All values saved to memory are cleared.

**NOOO** : Memory is empty.

**FuLl** : Memory is full.

**un, t** : Changeover of unit of measure.

**StoP** : Maximum wrench capacity is exceeded.

**dAtE** : Clock adjustment.

**bAt** : Low battery indicator.

**F Couples de serrage recommandés pour boulonnerie acier normalisée.**

Couples déterminés à 85 % de la limite élastique pour une boulonnerie noire ou zinguée, lubrification sommaire (coefficient de frottement 0,15).

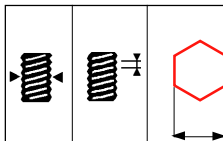

**GB Recommended torque values for standardised steel bolts**

Torque assessed at 85 % of the limit of elasticity for a black or zinc nut and bolt, basic lubrication (friction coefficient of 0.15).

**D Empfohlene Anziedrehmomente für genormte stahlschrauben**

Die Drehmomente liegen bei 85 % der Dehnungsgrenze bei verzinkten bzw. brünierten Verschraubungen (0,15 Reibungskoeffizient).

**NL Aanbevolen aanhaalkoppels voor genormaliseerde stalen bouten.**

Het moment is bepaald op een waarde van 85% van de rekgrens voor een zwarte of verzinkte gemonteerde bout, licht ingevet (wrijvingscoëfficiënt 0,15).

**E Pares de apriete aconsejados para pernos de acero normalizado.**

Pares determinados al 85 % del limite elástico para pernos negros o de zinc, ligeramente lubricados (coeficiente de rozamiento 0,15).

**I Coppie di serraggio raccomandate per bulloneria in acciaio normalizzato.**

Valori determinati all'85% del limite di elasticità dei bulloni di fabbricazione accurata ingrassati e montati con rondelle piatte (coefficiente di attrito 0,15).

Ø mm	ISO mm	mm	ISO 898/1		DIN ISO 898/1		NF E 25100		NF EN 20898-1	
			M	M	M	M	M	M	M	M
			5-6	5-8	6-8	8-8	9-8	10-9	12-9	
			C (Nm)	C (Nm)	C (Nm)	C (Nm)	C (Nm)	C (Nm)	C (Nm)	C (Nm)
1,6	0,35	3,2	0,075	0,105	0,12	0,16	0,18	0,235	0,275	0,275
2	0,40	4	0,159	0,222	0,254	0,339	0,381	0,498	0,582	0,582
2,5	0,45	5	0,33	0,463	0,529	0,705	0,793	1,04	1,21	1,21
3	0,50	5,5	0,57	0,8	0,91	1,21	1,38	1,79	2,09	2,09
4	0,70	7	1,3	1,83	2,09	2,78	3,16	4,09	4,79	4,79
5	0,80	8	2,59	3,62	4,14	5,5	6,27	8,1	9,5	9,5
6	1	10	4,49	6,2	7,1	9,5	10,84	14	16,4	16,4
8	1,25	13	10,9	15,2	17,4	23	26,34	34	40	40
10	1,50	16	21	30	34	46	52	67	79	79
12	1,75	18	37	52	59	79	90	116	136	136
14	2	21	59	83	95	127	143	187	219	219
16	2	24	93	130	148	198	224	291	341	341
18	2,5	27	128	179	205	283		402	471	471
20	2,5	30	182	254	291	402		570	667	667
22	2,5	34	250	350	400	552		783	917	917
24	3	36	313	438	500	691		981	1148	1148
27	3	41	463	649	741	1022		1452	1700	1700
30	3,5	46	628	880	1005	1387		1969	2305	2305
33	3,5	50	854	1195	1366	1884		2676	3132	3132
36	4	55	1096	1534	1754	2418		3435	4020	4020
39	4	60	1424	1994	2279	3139		4463	5223	5223
42	4,5	65	1760	2464	2816	3872		5515	6453	6453
45	4,5	70	2203	3085	3525	4847		6903	8079	8079
48	5	75	2659	3722	4254	5849		8330	9748	9748
52	5	80	3425	4795	5480	7335		10731	12558	12558
56	5,5	85	4270	5978	6832	9394		13379	15656	15656
60	5,5	90	5306	7428	8490	11673		16625	19455	19455
64	6	95	6382	8935	10212	14041		19998	23402	23402
<b>Re (N/mm²)</b>			<b>300</b>	<b>400</b>	<b>480</b>	<b>640</b>		<b>900</b>	<b>1080</b>	