



U.232-65

771147

U.232-90

771171

U.232-130

771180

U.232-160

771198

U.232-210

771201

U.232-270

771219

U.232-340

771227

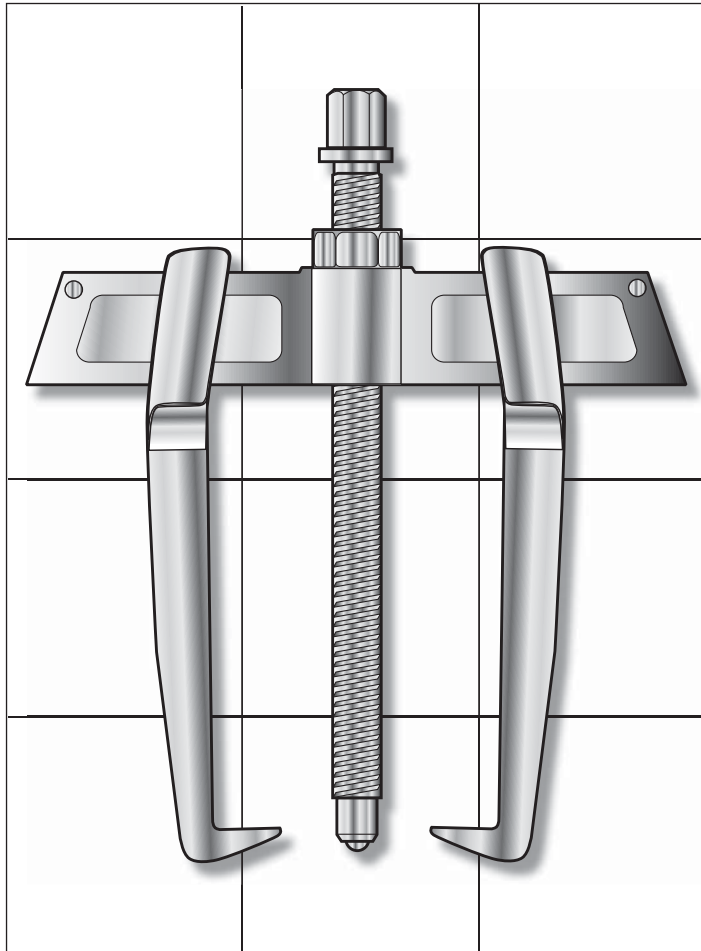

- Extracteurs à 2 griffes coulissantes
- Pullers with 2 sliding legs
- Abzieher mit 2 verstellbaren Abzieharmlen
- Trekkers met 2 verschuifbare bekken
- Extractores de 2 garras deslizantes
- Estrattori a 2 griffe scorrevoli
- Extractores com 2 garras corrediças
- Ściągacze z 2 łapami przesuwными
- Aftrækere med 2 forskydelige ben
- Εξωλκεια με 2 ολισθαιοντα ποδια

Notice d'instructions
Instruction manual
Bedienungsanleitung
Gebruiksaanwijzing
Guia de instrucciones
Istruzioni per l'utilizzo
Manual de instruções
Instrukcja obsługi
Brugsanvisning
Οδηγίες χρήσεως

 **FACOM**®

NU-U.232/0307







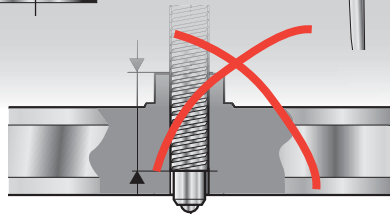
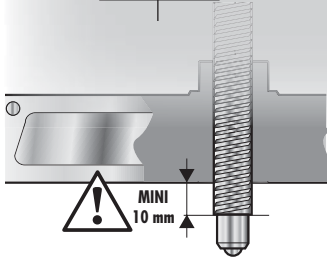
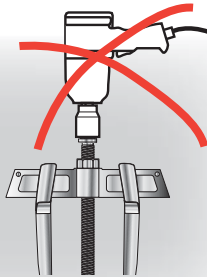
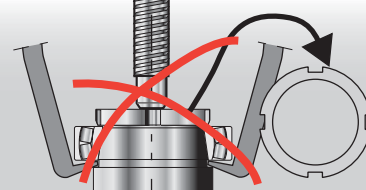
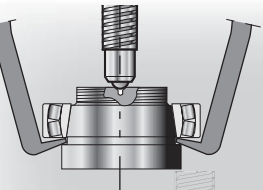
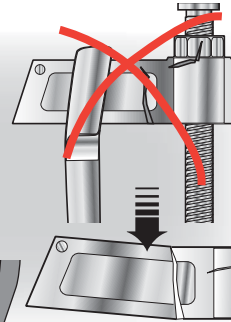
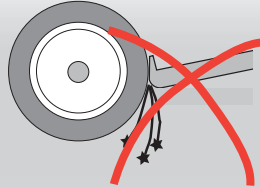
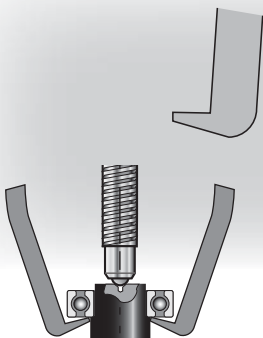
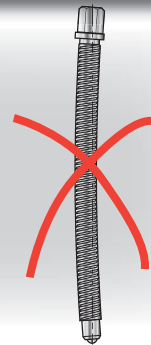
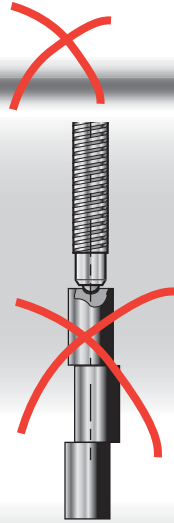
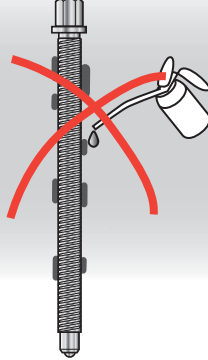
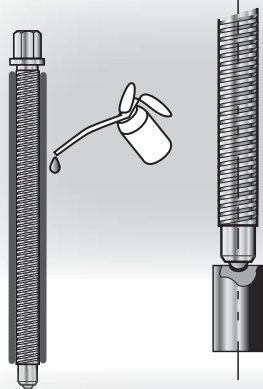

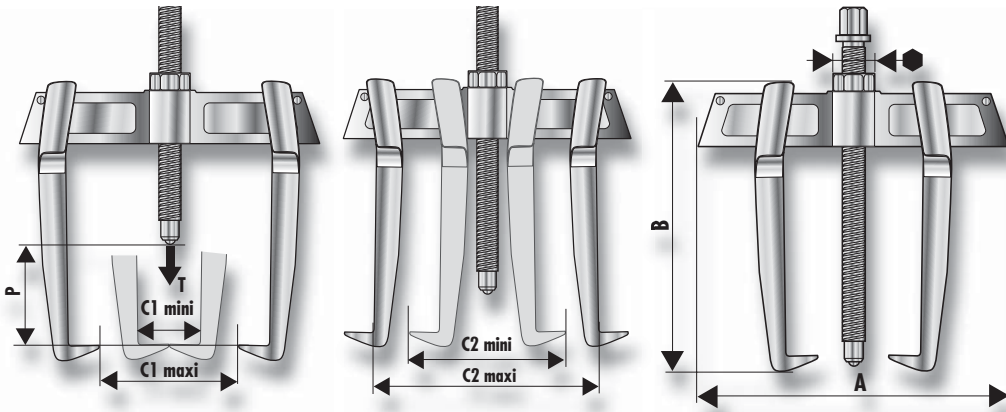

OK





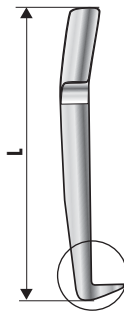



	C1 mini-C1 maxi mm	C2 mini-C2 maxi mm	P maxi mm	T tonnes	T kN			 mm	A mm	B mm	 kg
U.232-65	30 - 60	65 - 90	65	1,5	15	U.232G1	U.35P01	16	115	100	0,4
U.232-90	60 - 81	86 - 95	100	3	30	U.232G2	U.35SE1	21	146	155	0,9
U.232-130	60 - 122	86 - 136	100	3	30	U.232G2	U.35SE1	21	186	155	1
U.232-160	86 - 153	127 - 171	145	4	40	U.232G3	U.53S2A07	27	247	225	2,8
U.232-210	86 - 203	127 - 222	145	4	40	U.232G3	U.53S2A07	27	297	225	3
U.232-270	100 - 255	148 - 276	190	5	50	U.232G4	U.53S3-07	36	379	303	7,5
U.232-340	100 - 325	148 - 346	190	5	50	U.232G4	U.53S3-07	36	449	303	8,2

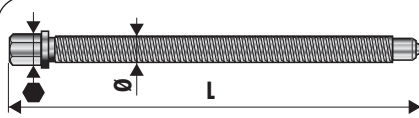
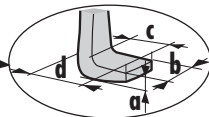

	L mm	a mm	b mm	c mm	d mm		 kg
U.232G1	100	4	8,5	10	16	U.232-65	0,08
U.232G2	155	5,2	9	15	24	U.232-90 / U.232-130	0,19
U.232G3	225	8	15	22	33	U.232-160 / U.232-210	0,56
U.232G4	303	11	17,5	25	43	U.232-270 / U.232-340	1,57



	Ø mm	L mm	 mm		 kg
U.35P01	M 12 x 1,75	130	13	U.232-65	0,08
U.35SE1	M 16 x 2	180	17	U.232-90 / U.232-130	0,20
U.53S2A07	M 20 x 2,5	280	17	U.232-160 / U.232-210	0,47
U.53S3-07	M 27 x 3	345	21	U.232-270 / U.232-340	1,28





BELGIQUE
LUXEMBOURG FACOM Belgie B.V.B.A.
Egide Walschaertsstraat 14-16
2800 MECHELEN
BELGIQUE
☎ : +32 (0) 15 47 39 35
Fax : +32 (0) 15 47 39 71

DANMARK
FINLAND
ISLAND
NORGE
SVERIGE FACOM NORDEN
Nordre Strandvej 119B
3150 HELLEBÆK
DENMARK
☎ : +45 49 76 27 77
Fax : +45 49 76 27 66

DEUTSCHLAND FACOM GmbH
Otto-Hahn-Straße 9
42369 Wuppertal
DEUTSCHLAND
☎ : +49 202 69 819-329
Fax : +49 202 69 819-350

ESPAÑA
PORTUGAL FACOM Herramientas S.L.
Poligono industrial de Vallecas
C/Luis 1º, s/n-Nave 95 - 2ºPl.
28031 Madrid
ESPAÑA
☎ : +34 91 778 21 13
Fax : + 34 91 380 65 33

ITALIA SWK Utensilerie S.r.l.
Via Volta 3
21020 Monvalle (VA)
ITALIA
☎ : (0332) 790 381
Fax : (0332) 790 307

NEDERLAND FACOM Gereedschappen BV
Kamerlingh Onnesweg 2
Postbus 134
4130 EC Vianen
NEDERLAND
☎ : (0347) 362 362
Fax : (0347) 376 020

SINGAPORE
FAR EAST FACOM TOOLS FAR EAST
N° 25 Senoko South Road
Woodlands East Industrial Estate
Singapore 758081
SINGAPORE
☎ : (65) 6752 2001
Fax : (65) 6752 2697

SUISSE
ÖSTERREICH
MAGYARORSZAG
ČESKÁ REP. FACOM WERKZEUGE GMBH
Ringstrasse 14
8600 DÜBENDORF
SUISSE
☎ : 41 44 802 8093
Fax : 41 44 802 8091

UNITED
KINGDOM
EIRE FACOM-UK
Europa view
SHEFFIELD BUSINESS PARK
Europa link
SHEFFIELD 59 1 XH
ENGLAND
☎ : (44) 114 244 8883
Fax : (44) 114 273 9038

POLSKA FACOM Tools Polska Sp. zo.o.
ul.Modlińska 190
03-119 Warszawa
POLSKA
☎ : (48 22) 510-3627
Fax : (48 22) 510-3656

FRANCE & INTERNATIONAL

Société FACOM
6-8, rue Gustave Eiffel B.P.99
91423 Morangis cedex
FRANCE
☎ : 01 64 54 45 45
Fax : 01 69 09 60 93
<http://www.facom.com>

En France, pour tous renseignements techniques sur l'outillage à main, téléphonez au : 01 64 54 45 14

