

V.131MA V.131MC

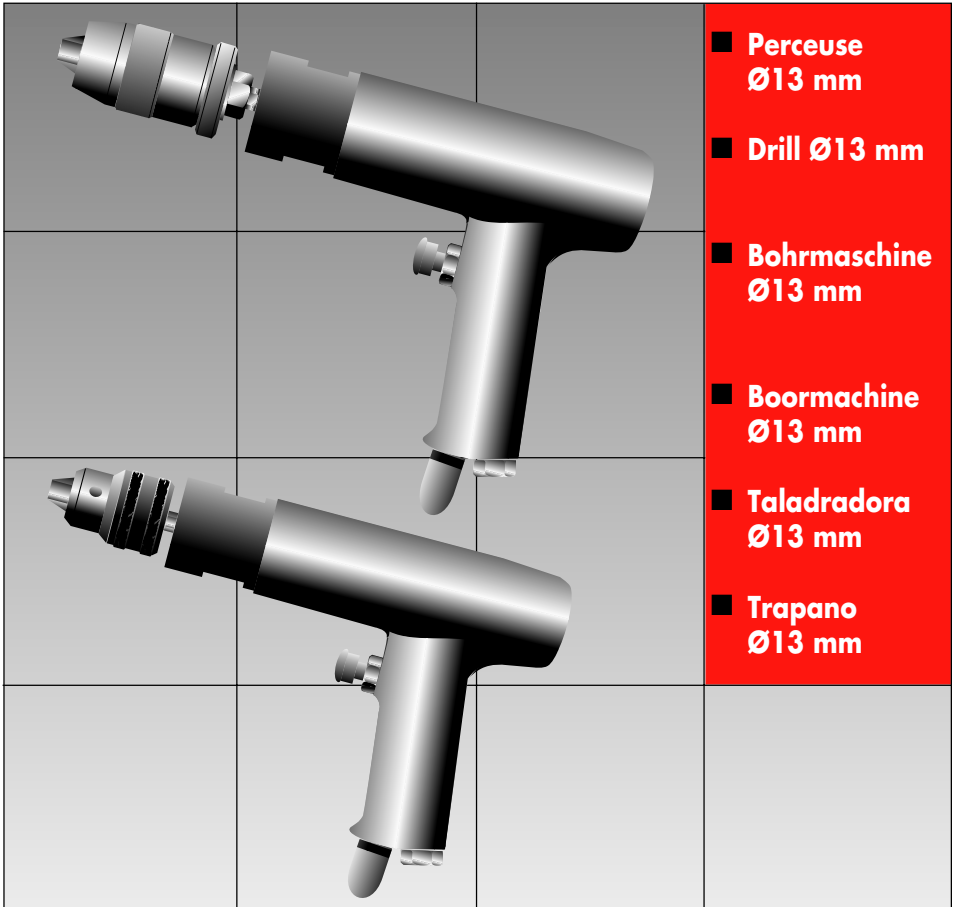

Notice d'instructions
Instruction manual
Bedienungsanleitung
Gebruiksaanwijzing
Manual de instrucción
Istruzioni per l'utilizzo
NU-V.131/98



Ø 1,5 mm
↓
Ø 13 mm

760 t/mn

35 Nm

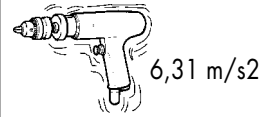
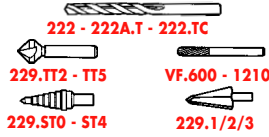
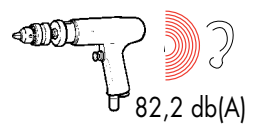
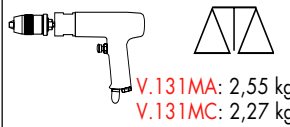
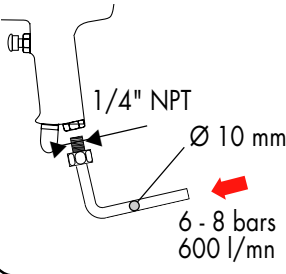

V.130A3 → V.131MA
V.130A1 → V.131MC

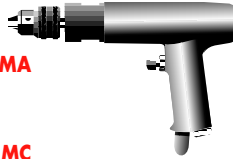

15 bars maxi / 20°C
10 bars maxi / 60°C
1500 l/mn maxi

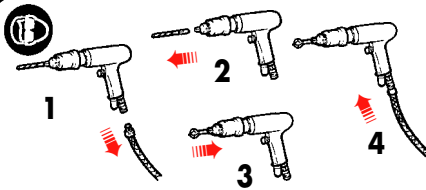
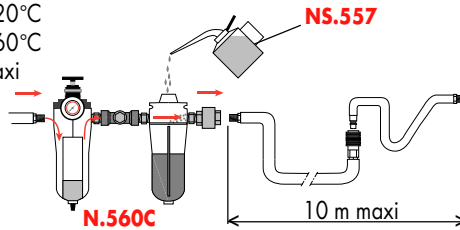

Porter des lunettes de sécurité
Wear eye protectors
Sshutzbrille tragen
Een veiligheidsbril dragen
Utilizar gafas de seguridad
Portare gli occhiali di sicurezza



Pour garder la machine en bon état, remplacer les pièces d'usure toutes les 200 heures d'utilisation.

To keep the machine in proper working order, change wear parts after 200 hours to use.

Um die Maschine in gutem Zustand zu erhalten, Gebrauchsteile alle 200 Betriebsstunden austauschen.

Om deze machine in goede staat te houden, dienen de aan slagtage onderheveige onderdelen na 200 uren gebruik te worden verwisseld.

Para mantener la maquina en buen estado, cambiar las piezas de desgaste despues de 200 horas de utilización.

Per mantenere la macchina in buono stato, cambiare le parti d'usura dopo 200 ore di funzionamento.

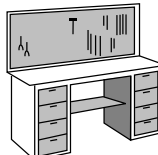
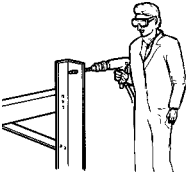

V.101SE1.....SE9

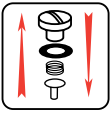

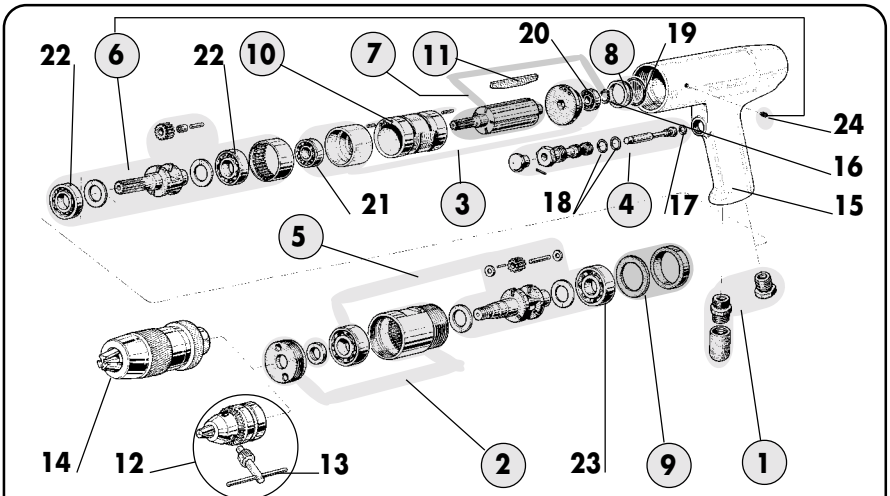
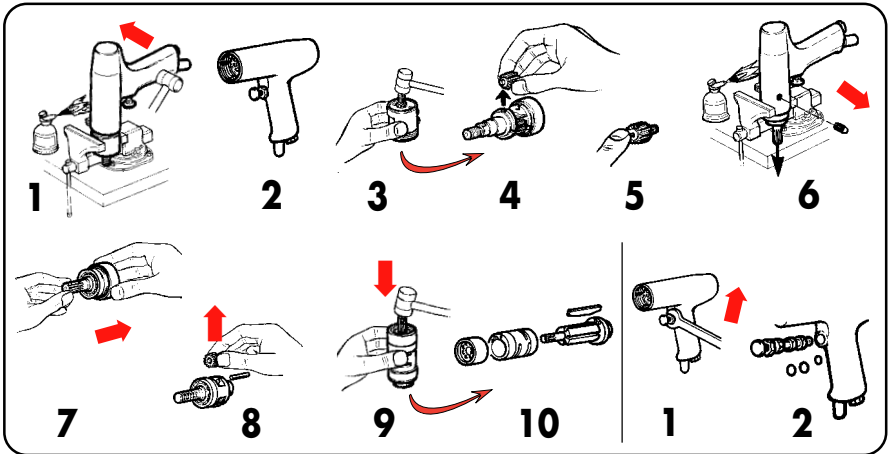
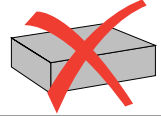

V.101SE1.....SE9



①	V.101SE1	⑨	V.131SE8	⑰	BAGUE.RO0500-178
②	V.131SE1	⑩	V.131SE9	⑱	BAGUE.RO1000-178 (2)
③	V.131SE2	⑪	V.131-046J5	⑲	BAGUE.RO2400-200
④	V.131SE3	⑫	V.130A1	⑳	ROULEMENT.6900
⑤	V.131SE4	⑬	V.130A2	㉑	ROULEMENT.6001
⑥	V.131SE5	⑭	V.130A3	㉒	ROULEMENT.16003 (2)
⑦	V.131SE6	⑮	V.131-001	㉓	ROULEMENT.6203 (2)
⑧	V.131SE7	⑯	ANNEAU.81-0100	㉔	VIS.STHc,M5x6T

BELGIQUE FACOM Belgique S.A./NV
LUXEMBOURG Weihoek 4
1930 Zaventem
BELGIQUE
☎ : (02) 714 09 00
fax : (02) 721 24 11

DANMARK FACOM
FINLAND Navervej 16B
ISLAND 7451 SUNDS
NORGE DANMARK
SVERIGE ☎ : (45) 971 444 55
fax : (45) 971 444 66

DEUTSCHLAND FACOM GmbH
Postfach 13 22 06
42049 Wuppertal 
Otto-Wels-Straße 9
42111 Wuppertal 
DEUTSCHLAND
☎ : (0202) 270 63 0
fax : (0202) 270 63 50

ESPAÑA FACOM Herramientas, S.L.
PORTUGAL Poligono industrial de Vallecas
C/.Luis 1° s/n-Nave 95-2° Pl.
28031 Madrid
ESPAÑA
☎ : (91) 778 21 13
fax : (91) 778 27 53

ITALIA U.A. FACOM Italia
Via Volta 3
21020 Monvalle (VA)
ITALIA
☎ : (0331) 985 811
fax : (0331) 985 930

NEDERLAND FACOM Gereedschappen BV
Kamerlingh Onnesweg 2
Postbus 134
4130 EC Vianen
NEDERLAND
☎ : (0347) 362362
fax : (0347) 376020

SINGAPORE FACOM TOOLS FAR EAST Pte Ltd
FAR EAST 15 Scotts Road
Thong Teck Building # 08.01.02
Singapore 228218
SINGAPORE
☎ : (65) 732 0552
fax : (65) 732 5609

SUISSE FACOM S.A./AG
ÖSTERREICH 12 route Henri-Stéphan
MAGYARORSZÁG 1762 Givisiez/Fribourg
ČESKÁ REP. SUISSE
☎ : (4126) 466 42 42
fax : (4126) 466 38 54

UNITED FACOM Tools Ltd
KINGDOM Bridge Wharf - Bridge Road
EIRE CHERTSEY - SURREY KT16 8LJ
UNITED KINGDOM
☎ : (01932) 566099
fax : (01932) 562653

UNITED FACOM TOOLS Inc.
STATES 3535 West 47th Street
Chicago Illinois 60632
U.S.A.
☎ : (773) 523 1307
fax : (773) 523 2103

FRANCE Société FACOM
& 6-8 rue Gustave Eiffel BP.99
INTERNATIONAL 91423 Morangis Cédex
FRANCE
☎ : 01 64 54 45 45
fax : 01 69 09 60 93
<http://www.facom.fr>

